



MF SERIES



Vision Manufactured

At Quaser Group, we dedicate to

Creating a world where there is no gap between design concept and manufacturing to maximize the power of engineering.

Whatever you design, we can make it to upgrade your competitive edge.



Series Overview

Workpiece Size & Machine Structure	4
Cutting Area and Interference	6
Application Samples	8
Spindle Technology	9
Rotary Table	12
ATC System	13
Automation	14
Easy Operation	16
Coolant System & Chip Management	18
Accuracy Table	19
Technical Data	20
Options	24
Spindle	26
Layout & Dimension	27
Carbon Reduction & Green Power	30
QUASER Group	31



Workpiece Size & Machine Structure

▲ MF400

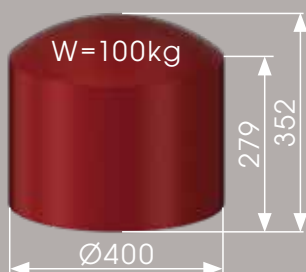

▲ MF500



5 axes positioning/ 4 axes simultaneously
0iMF PLUS, SIEMENS 828D, MITSUBISHI
M830

5 axes simultaneously
FANUC 31iB5, SIEMENS 840D, HEIDENHAIN
TNC640

Note The object might be different from the photos of catalogue if there is any specification update

▲ MF700

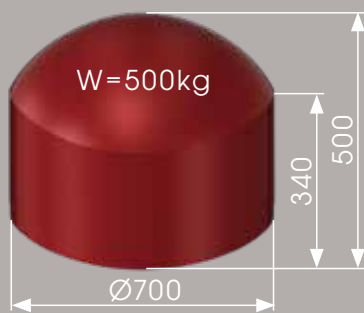

Cutting Area & Interference

MF400

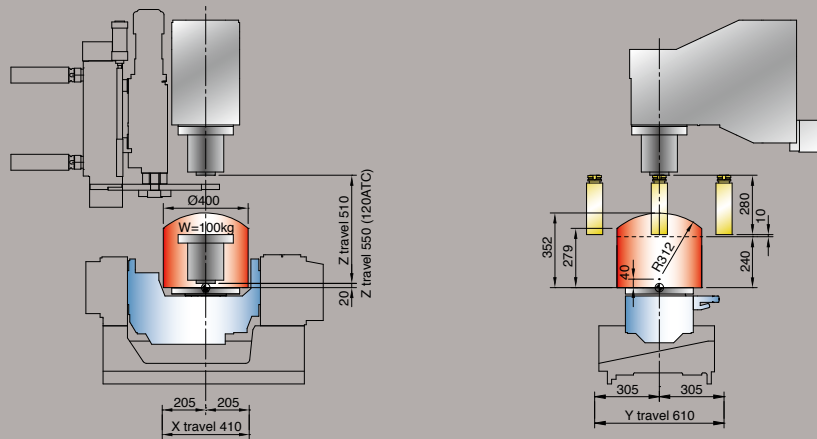

MF500

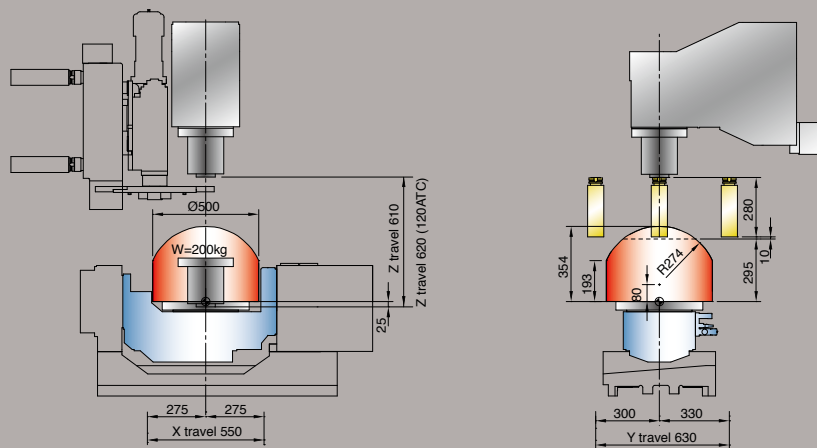

MF700

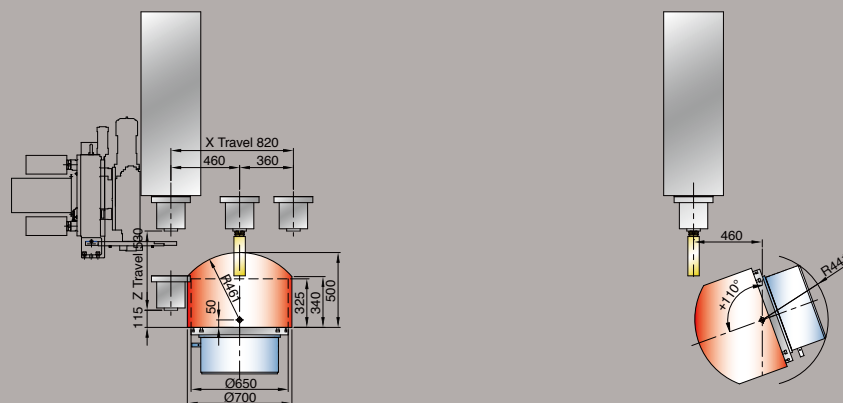

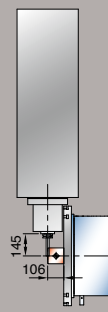
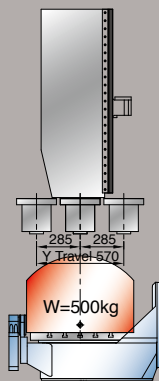
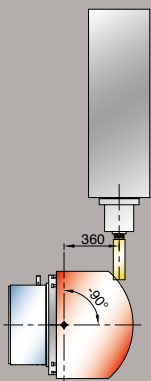
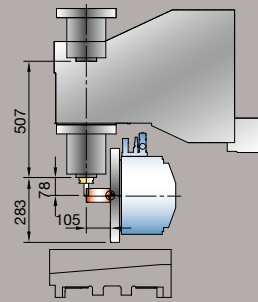
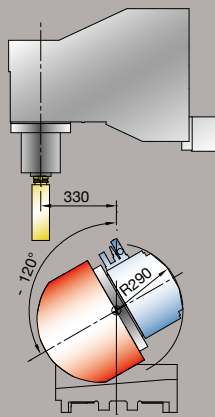
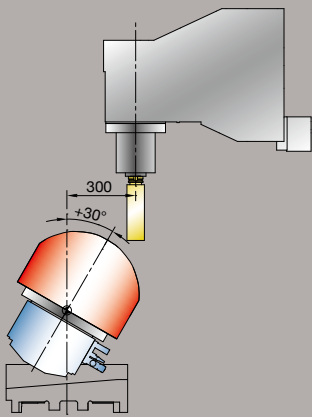
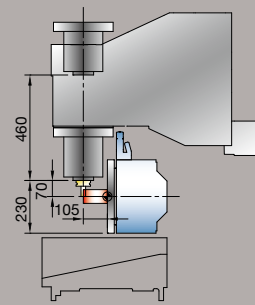
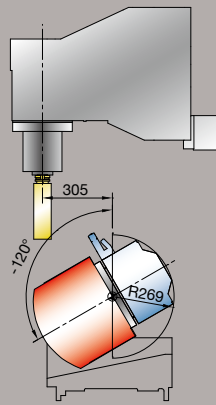
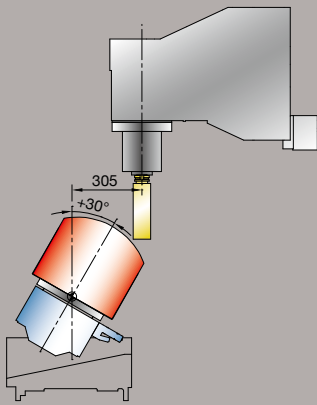

Application Samples

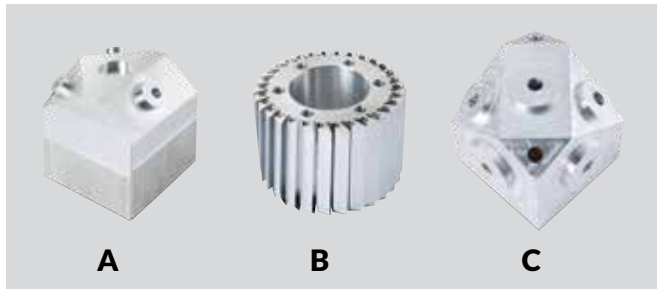

- A. Three-way valves
- B. Heat dissipation fins
- C. Multi-way valves
- D. Testing workpiece
- E. Heat dissipation fins
- F. Lens holder

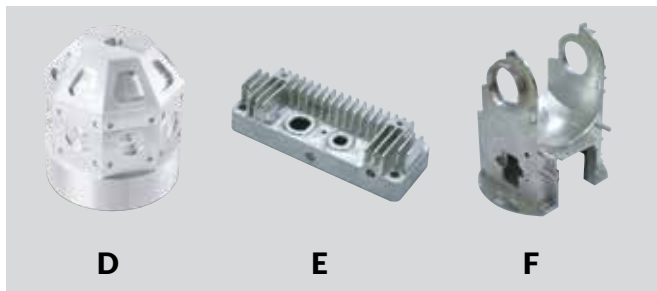

MF700

Curve contour and smoothness to meet industry requirements for overall performances, working efficiency and dimensional accuracy

Forged Aluminum Wheel	Specifications
Material	A6061-T6
Machining Size	Ø 540 x 300 mm (L)
Machining Time	6 hr 28 min



Spindle Technology



- 18.5 (S6-25%) Direct Coupling Spindle with 12,000 RPM, 15,000 RPM (optional)
- CTS options for Highspeed Machining

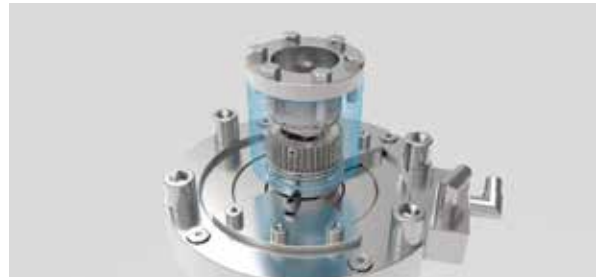

Direct Coupling

The MF700's spindle uses a coupling that ensures outstanding power transfer efficiency with a moment of inertia of under 0.003 kgm^2 .

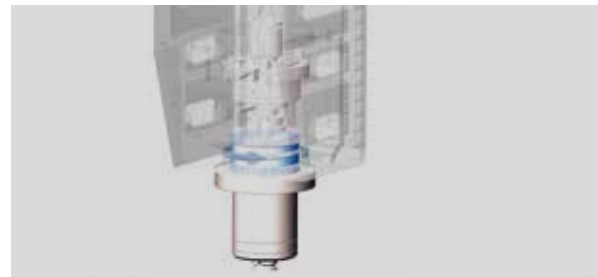

Inverter Chiller

Spindle heat cooling jacket provide stable temperature to high-speed shaft and bearing.

Spindle Taper	
Max. spindle speed (min^{-1})	12,000
Spindle base speed (min^{-1})	1,500
Spindle power output kW (S6-25%)	18.5
Spindle power output Nm (S6-25%)	118
Spindle transmission	Coupling
Spindle bearing	Ø80 / << >>

Note: For detailed spindle specifications, refer to P26





MF 700

MF700's space friendly design includes a wall mounted rotary table hiding the tilting axis motor under the column, ensuring larger processing area for a small and compact machine footprint.

Result is the best use of space proximity and easy operation.

Maximum loading capacity / 500KG

Max Workpiece Diameter / 700mm

Max workpiece Height / 500mm



Rotary Table

Strong and Rigid



Combining alloy steel and aluminum bronze greatly reduces friction coefficient, effectively transmitting motor torque.

	MF400		MF500		MF700	
	Rotary Axis (C-axis)	Tilting Axis (A-axis)	Rotary Axis (C-axis)	Tilting Axis (A-axis)	Rotary Axis (C-axis)	Tilting Axis (B-axis)
Drive method	Worm		Worm		Worm	
Max. swing (mm)	Ø400		Ø500		Ø700	
Table load capacity (kg)	100		200		500	
Allowable unblancing workpiece moment (Nm)	110		200		200	
Maximum R.P.M (min ⁻¹)	25	25	16.6	11.1	25	25

ATC and ATC Maintenance

Flexible Options



The MF700's standard tool capacity is 48T, but we also offer optional upgrades to 60, 90, and 120 tools to meet various machining demands.

Pull stud and applicable tools

B	tool median point distance
C	tool weight
MOMENT=W*B≤(10.29N-m)	

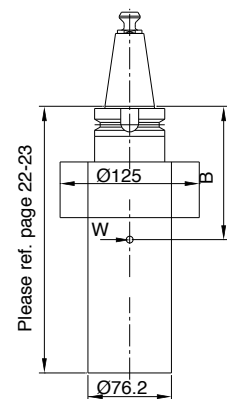
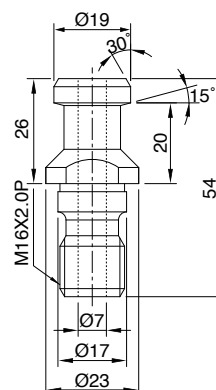
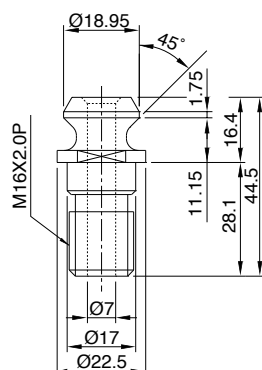
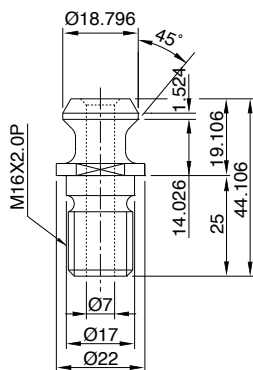

Automation



Technical Details (Cell)

Pallet size	mm	400x400 / 500x500
Max. work piece size	mm	Ø500x350 / Ø600x350
Pallet load capacity	kg	250 (with pallet) / 350 (with pallet)
Number of pallet	pcs	6 or 8
Exchange Way		Lift and rotation
Weight	kg	2,800
Floor space W x D x H	mm	2,085 x 2,030 x 2,200

Note: Layout of MF700 with Cell Pallet System.

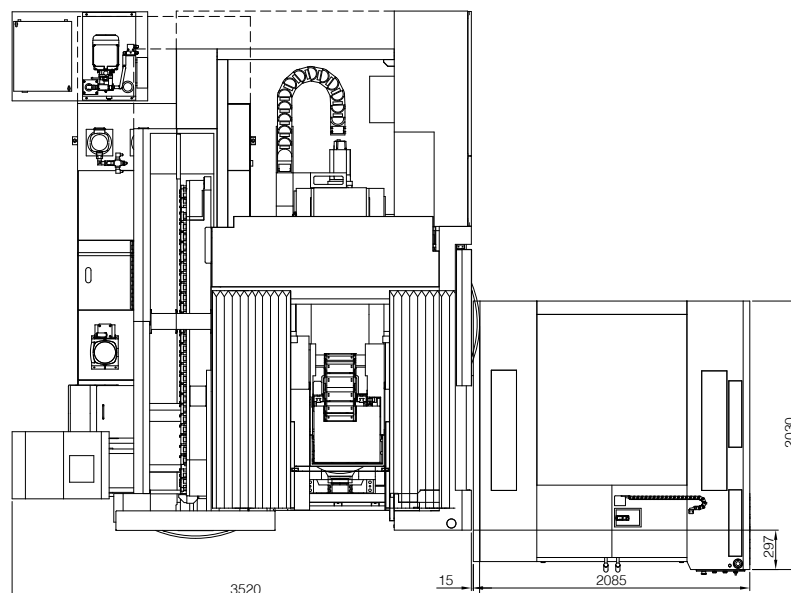



Technical Details HALTER LoadAssistant 20

Maximum load capacity robot arm	kg	20
Minimum workpiece dimension LxW	mm	10x10
Maximum workpiece dimension LxW	mm	230x230
Maximum height of workpiece	mm	250
System size L x W x H	mm	1,750 x 1,434 x 2,220



Technical Details (EROWA)

Transfer weight	kg	40
X - axis travel	mm	1,380
Z - axis travel	mm	1,680
Swivel rage		350°
System size L x W x H	mm	2,014 x 1,069 x 2,612

Both side doors are available to install automatic system, with EROWA Robot, it's easy to achieve the demand of FMS.

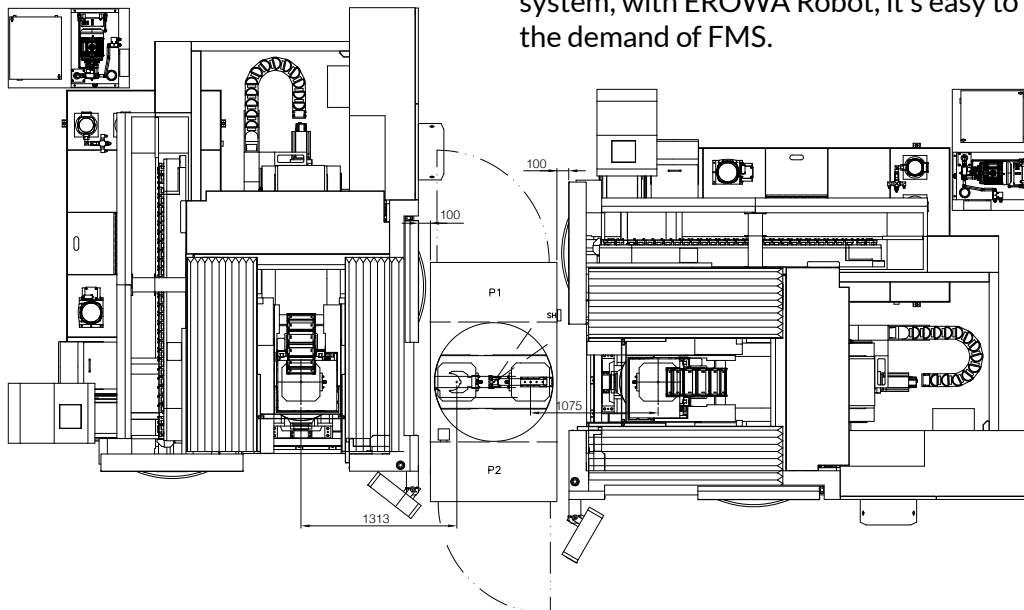

Easy Operation

Working with Convenience and Safety



Accessibility (MF700)

- a. Max. size when front door open: 850mm
- b. From center of table to front door: 600mm
- c. Side door opening: 740mm
- d. Distance from operator to spindle: 365mm



(MF400/MF500)

- e. Max. size when operator door open
 - MF400 / MF500: 870mm
- f. From center of table to operator door
 - MF400 / MF500: 605mm



A. Guard with Top Side Bellow(optional)



B. Side Auto Door(optional)



C. Electrical box
Neat and clear wiring configuration



D. Green solutions
Quick steps 123



E. Control Panel
Ergonomic operation panel with adjustable angle.



F. Centralized Configuration
Lubrication and pneumatic panel easy to maintenance.



Chip Removal System Design

Save machine cleaning and maintenance time

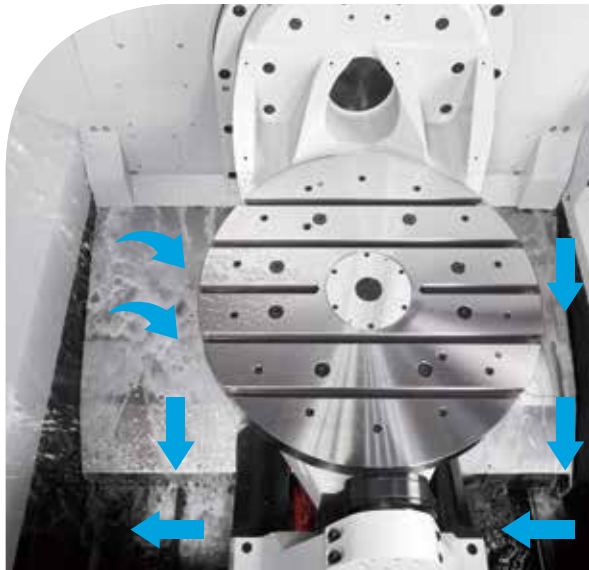

-Optimized chip removal system design allows chips to directly fall on the chip conveyor.

-The high-efficiency chip conveyor under the machine discharges the chips quickly and in large quantities.

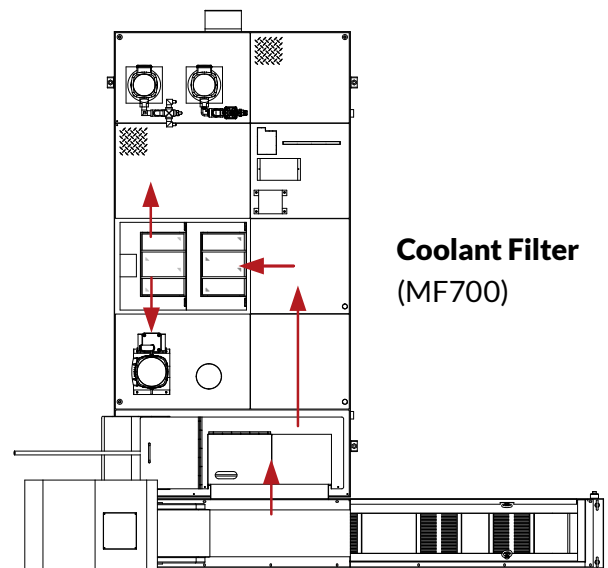
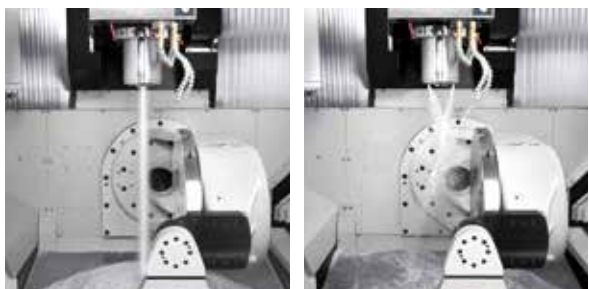

-Internal chip augers (MF400/MF500)

Accuracy table

Accuracy Position / Repeatability

ISO 10791-4 0.010mm / 0.007mm

-Scraping all casting mounting surface to improve machine accuracy and flatness



Table Accuracy

-B/C indexing accuracy: 20/20 sec
(with optional angle encoder: 12/12 sec)

-B/C repeatability accuracy: 12/12 sec
(with optional angle encoder: 4/4 sec)



Accuracy

-Linear scales and angle encoders are installed



DBB

Y-Z plane measured results

Machine	MF700
Radius	150.000mm
Feedrate	500.0mm/min

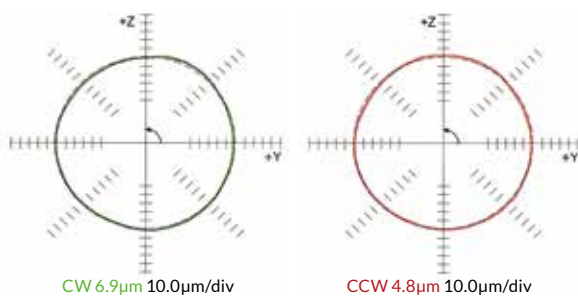

Technical Data

Technical Data

MF400

Spindle code	12C	15C	20C
--------------	-----	-----	-----

Work Range

Table size (mm)	Ø320
Travel X / Y / Z (mm)	410 / 610 / 510 ⁽²⁾
Travel A ⁽¹⁾ (degree)	+30° ~ -120°
Travel C (degree)	360° (Continuous)
Max. swing (mm)	Ø400
Table surface to spindle nose (mm)	20 ~ 530
Spindle nose to tilting center (mm)	20 ~ 530
Max. work piece size (mm)	Ø400 x 300
Table load capacity (kg)	100 (110 Nm)

Feed drive

Feed force X / Y / Z (N)	5,760 / 5,760 / 10,472 (F)	6,283 / 6,283 / 11,519 (F)
	6,283 / 6,283 / 14,137 (S)	6,283 / 6,283 / 14,137 (S)
	6,283 / 11,781 / 11,781 (M)	
	6,283 / 6,283 / 11,519 (F)	6,283 / 6,283 / 11,519 (F)
	6,283 / 6,283 / 14,137 (S)	6,283 / 6,283 / 14,137 (S)
	9,268 / 11,310 / 11,310 (T)	9,268 / 11,310 / 11,310 (T)
Rapid movement X / Y / Z (m/min)	36 / 36 / 24	
Rapid movement A / C (min ⁻¹)	A=25 / C=25	
Acceleration X / Y / Z (m/s ²)	3 / 3 / 2 (F; M; T) 3 / 2 / 2 (S)	

Accuracy Positioning / Repeatability

ISO 10791-4	0.010mm / 0.007mm
-------------	-------------------

Control: (F) FANUC (S) SIEMENS (M) MITSUBISHI (T) HEIDENHAIN

5 FACE : (F) 0iMF Plus (S) 828D (M) M830 5 AXES : (F) 31iB5 (S) 840D (T) TNC640

MF500

MF700

12C	15C	20C	12C	15C	20C
-----	-----	-----	-----	-----	-----

<p>Ø 410</p> <p>550 / 630 / 610⁽³⁾</p> <p>+30° ~ -120°</p> <p>360° (Continuous)</p> <p>Ø500</p> <p>-25 ~ 585</p> <p>-25 ~ 585</p> <p>Ø 500 x 300</p> <p>200 (200 Nm)</p>	<p>Ø650</p> <p>820 (-460 ~ +360) / 570 (-285 ~ +285) / 530</p> <p>+110° ~ -90°</p> <p>360° (Continuous)</p> <p>Ø700</p> <p>115 ~ 645</p> <p>65 ~ 595</p> <p>Ø700 x H500</p> <p>500</p>
---	--

5,760 / 10,472 / 10,472 (F)	6,283 / 6,283 / 11,519 (F)	11,519 / 11,519 / 11,519 (F)
6,283 / 14,137 / 14,137 (S)	6,283 / 14,137 / 14,137 (S)	18,850 / 14,137 / 14,137 (S)
6,283 / 11,781 / 11,781(M)		
6,283 / 11,519 / 11,519 (F)	6,283 / 11,519 / 11,519 (F)	11,519 / 11,519 / 11,519 (F)
6,283 / 14,137 / 14,137 (S)	6,283 / 14,137 / 14,137 (S)	18,850 / 14,137 / 14,137 (S)
9,268 / 11,310 / 11,310 (T)	9,268 / 11,310 / 11,310 (T)	14,661 / 11,310 / 11,310 (T)
36 / 36 / 24	36 / 36 / 36	
A=11.1 / C=16.6	B=25 / C=25	
3 / 3 / 2	3 / 3 / 3	

0.010mm / 0.007mm

Note: ⁽¹⁾ MF700 is B axis ⁽²⁾ Option 120 ATC Z axis travel 550 mm ⁽³⁾ Option 120 ATC Z axis travel 620 mm

Technical Data

Technical Datas

MF400

Spindle code	12C	15C	20C
--------------	-----	-----	-----

Main spindle

Spindle taper	BBT40
---------------	-------

Tool changer

Tool selection	Random
Magazine positions	30 (std.) 48 / 60 / 120 (opt.)
Max. tool diameter (mm)	76.2
w/o adjacent tool (mm)	125
Max. tool length (mm)	280
Max. tool weight (kg)	7
CTC time - ISO 10791-9 (sec.)	9 ±0.2 (F; S; M; T)

Coolant System

Coolant tank capacity (Liter)	480
Pump capacity- Nozzle coolant	75 L/min., 3 bar
-Wash down	75 L/min., 3 bar

Machine Size

Height (mm)	3,070	3,140
Floor space W x D (mm) - 30/48ATC	2,020 x 3,120	
Floor space W x D (mm) - 60ATC	2,020 x 3,160	
Weight (kg)	7,300(30ATC) / 7,600(48ATC) / 7,800(60ATC) / 8,670 (120ATC)	

Connections

Main power	220V or 380V or 400V or 415V / 50Hz or 60Hz		
Power consumption (KVA)	25 (F; S; M)	35 (F) 30 (S)	30 (F)
	30 (F; T) 25 (S)	35 (F; T) 30 (S)	30 (F)

MF500			MF700		
12C	15C	20C	12C	15C	20C
BBT40			BBT40		
Random 30 (std.) 48 / 60 / 120 (opt.) 76.2 125 280 7 9 ±0.2 (F; S; M; T)			Random 48 (std.) 60 / 90 / 120 (opt.) 76.2 125 300 7 9 ±0.2 (F; S; M; T)		
480 75 L/min., 3 bar 75 L/min., 3 bar			450 75 L/min., 3 bar 75 L/min., 3 bar		
3,175 2,280 x 3,225 2,280 x 3,610 7,480(30ATC) / 7,780(48ATC) / 7,980(60ATC) / 8,850(120ATC)			3,670 3,520 x 4,400 3,520 x 4,400 10,500(48ATC) / 10,700(60ATC) / 11,420(90ATC) / 11,520(120ATC)		
220 ~ 230V / 50-60Hz, 380 ~ 415V / 50-60Hz			220 ~ 230V / 50-60Hz, 380 ~ 415V / 50-60Hz		
25 (F; S; M)	35 (F; S)	30 (F)	30 (F) 40(S)	35 (F) 40(S)	
30 (F; T) 25 (S)	35 (F; S) 40 (T)	30 (F)	30 (F) 40 (S; T)	35 (F) 40 (S; T)	



Standard/ Option Accessories

Standard / Option accessories

MF400

	12C	15C	20C
FANUC 0iMF PLUS 15" (5 Faces)	○	○	○
SIEMENS 828D 10.4" (5 Faces)	○	○	×
MITSUBISHI M830 10.4" (5 Faces)	○	×	×
FANUC 31iB5 15" (5 Axes)	○	○	○
SIEMENS 840D 19" (5 Axes)	○	○	×
HEIDENHAIN TNC640 19" (5 Axes)	○	○	×
Spindle oil chiller	●	●	●
30 position tool magazine	●	●	●
48 position tool magazine	○	○	○
60 / 90 ^{*1} / 120 position tool magazine	○	○	○
Pull stud for BT tooling system	○	○	○
Balance tooling for spindle warm up	○	○	○
ATC auto door	○	○	○
X / Y / Z linear scale	○	○	○
DD table package	×	×	×
Rotary & Tilting encoder	○	○	○
Transformer	○	○	○
Work probe ^{*2}	○	○	○
Tool length / breakage measurement ^{*2}	○	○	○
2 Port through table	○	○	○
4 Port through table ^{*3}	○	○	○
Coolant through spindle 20 bar	○	○	○
Scrape type Chip conveyor	○	○	○
Oil-mist collector	○	○	○
Filtration unit (paper)	○	○	○
Work light	●	●	●
Machine status light	●	●	●
Documentation (USB)	●	●	●
CE	○	○	○

Note: ^{*1} 90 ATC only for MF700 option ^{*2} BLUM or RENISHAW ^{*3} port ready only

Spindle

Spindle code	SC-4.2			MC-4.1R	MC-4.0R
Shaft diameter	Ø80 / Ø70			Ø80 / Ø65	Ø70 / Ø60
Spindle Taper	ISO-40			ISO-40	ISO-40
Transmission	Coupling			Coupling	Coupling
Spindle Speed	12,000			15,000	20,000
FANUC	α i12 / 12,000	α iT12 / 12,000		α iT15 / 15,000	α IL8 / 20,000
Spindle base speed	1,500	1,500		1,400	1,500
Spindle output power kW S6-25%	18.5	18.5		26	15
Spindle output torque Nm S6-25%	118	118		177	125
HEIDENHAIN	QAN200U	QAN200UH	QAN260MH	1PH8131	-
Spindle base speed	1,500	1,500	1,500	2,000	-
Spindle output power kW S6-25%	17	17	32	27.7	-
Spindle output torque Nm S6-25%	108	108	204	132	-
SIEMENS	1PH8105	1PH8105	1PH8133	1PH8131	-
Spindle base speed	1,500	1,500	1,500	2,000	-
Spindle output power kW S6-25%	13.5	13.5	28.5	27.7	-
Spindle output torque Nm S6-25%	85	85	182	132	-
MITSUBISHI	SJ-VK30-16ZT	SJ-VKS30-16ZT	-	-	-
Spindle base speed	1,400	1,400	-	-	-
Spindle output power kW 30min	15	15	-	-	-
Spindle output torque Nm 30min	102	102	-	-	-
CTS Availability	×	●	○	○	○
Available NC adapting	○ FANUC	○ HEIDENHAIN	○ SIEMENS	○ MITSUBISHI	
MF400	○ ○ ○ ○	○ ○ ○ ○	-	○ ○ ○	○ ○ ○
MF500	○ ○ ○ ○	○ ○ ○ ○	-	○ ○ ○	○ ○ ○
MF700	-	○	○ ○ ○	○ ○ ○	○ ○ ○

● Standard ○ Option × N/A

Layout & Dimension

Table Dimension

MF400

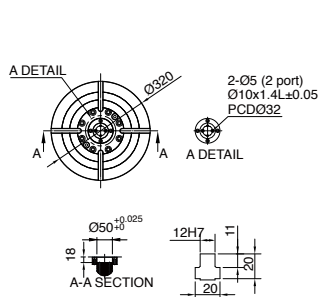

MF500

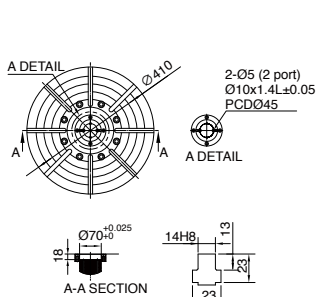

MF700

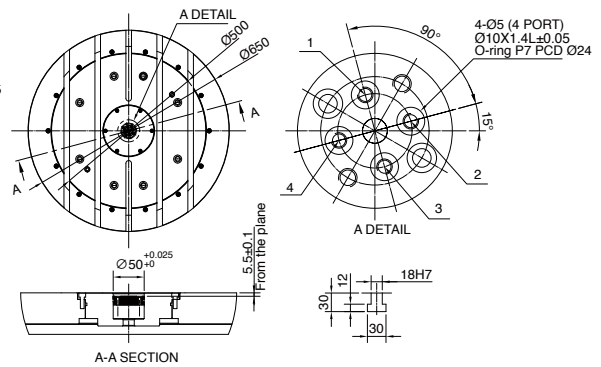

MF400

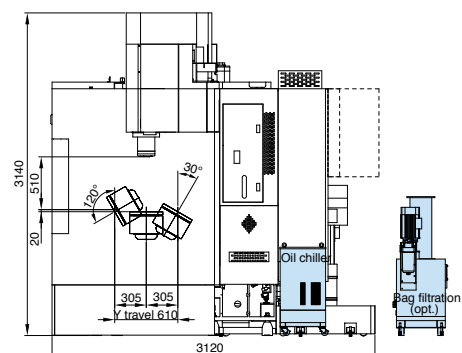
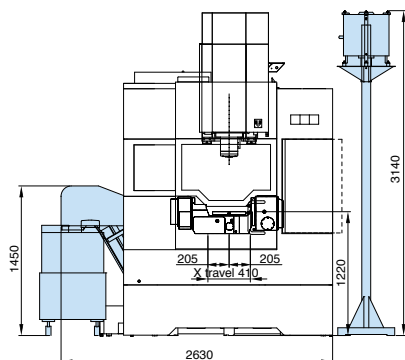
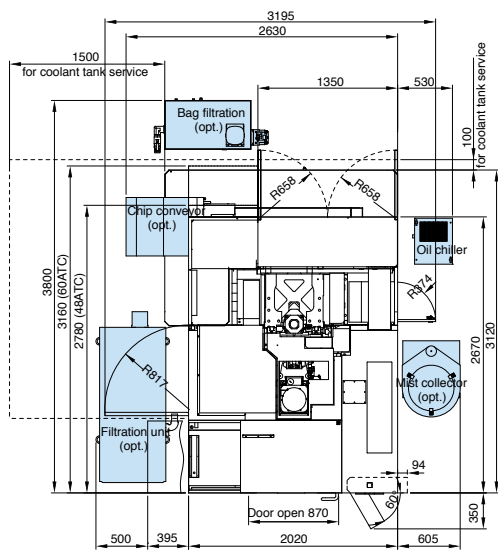

MF500

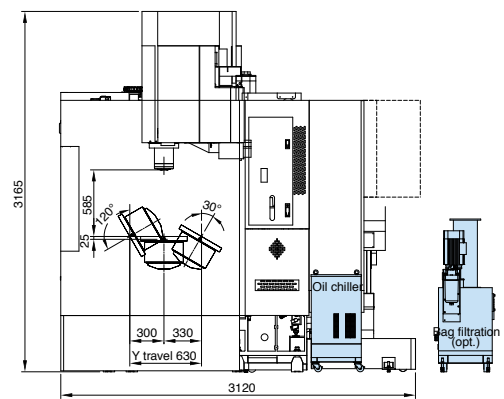
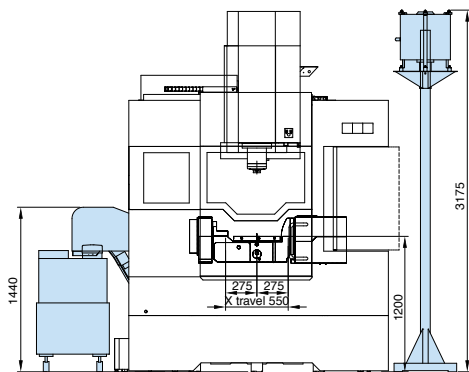
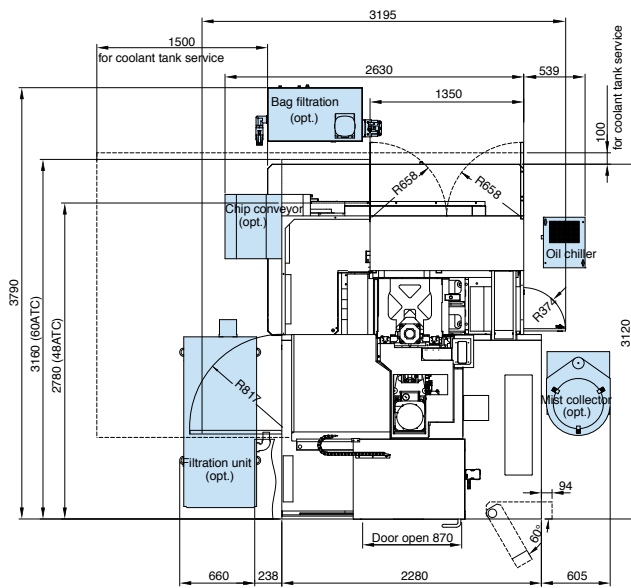

MF700

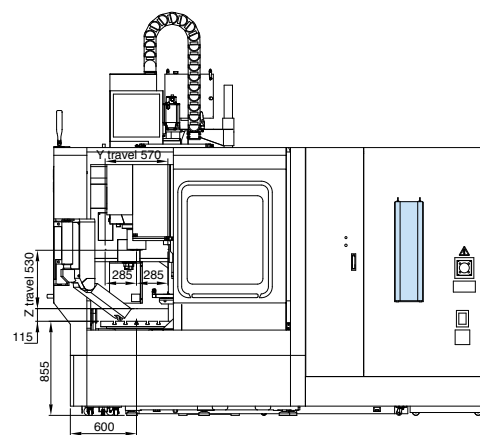
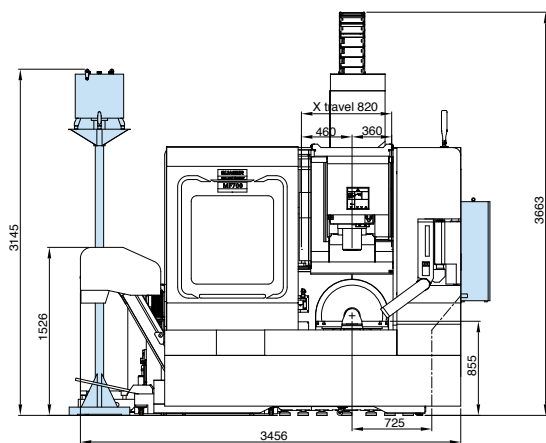
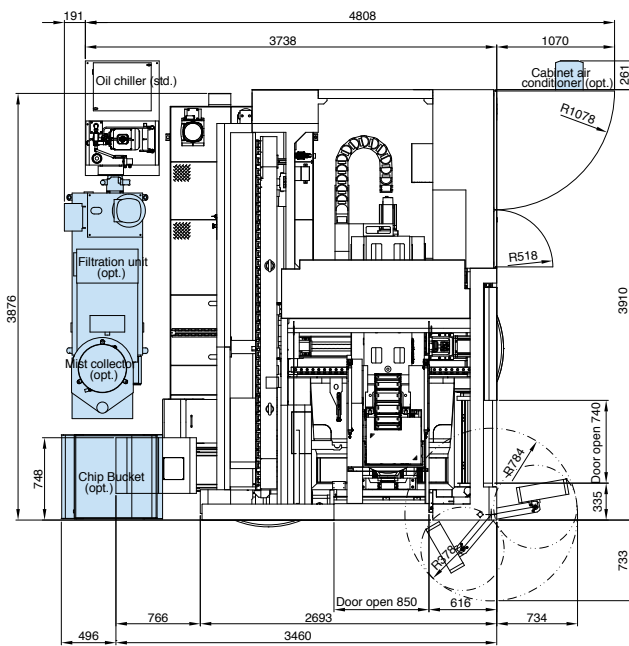

Carbon Reduction & Green Power



Quaser in the future will not only dedicate to technology in new field, but also contribute to escalating Cooperate Social Responsibility, such as obtain carbon neutral within 5 years. Instead of urging, we will lead stakeholders to reach the goal together.

We are trying to implement a sustainable economy, build healthy cities with the world, and create a prosperous future.

Business or Citiuens, everyone is accountable to save the world.

We all know that without your support, we would never achieve it.

Let's create a green future and start it from today, everyday!

ISO 9001 / ISO 14001 / ISO 14952-1



QUASER Group



Taichung Taiwan

No.3, Gong 6th Rd., Youshih Industrial Park,
Dajia Dist, Taichung City 43768, Taiwan

www.quaser.com
sales@qmt.com.tw
T +886 426821277
F +886 426821266



Jiangsu China

(B)No.287, Kangzhuang Rd., Zhoushi Town,
Kunshan City,
Jiangsu, P.R. China

qmtc@qmt.com.tw
T 051282627139
F 051282627138



Heiligenhaus Germany

Carl-Zeiss-Straße 22, 42579 Heiligenhaus,
Germany

qe@qmt.com.tw
T +49 205 6259 6780
F +49 173 5488 713



South Carolina USA

3049 Southcross Boulevard, Suite 105 Rock
Hill, South Carolina 29730 USA

sales@winbrogroup.com
T +1 803 985 9481 (Sales)
F +1 888 948 6400 (Service)



Leicestershire UK

Unit 1, Gelders Hall Road, Shepshed
Leicestershire LE12 9NH, UK

sales@winbrogroup.com
T +44 (0)1530 516 000

